

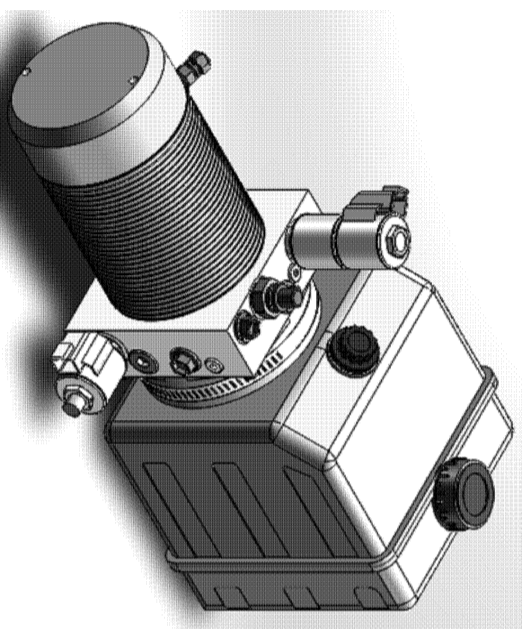

VDP-U-MD24220-56-P

Technical Attributes

Model Code	VDP-U-MD24220-56-P
Motor Voltage	24V
Motor Power	2.2kW
Rated Speed	2800rpm
Pump Capacity	1.6mL/r
System Pressure	17MPa
Tank Capacity	4L
Oil Port	G1/4"



Outline Dimensions

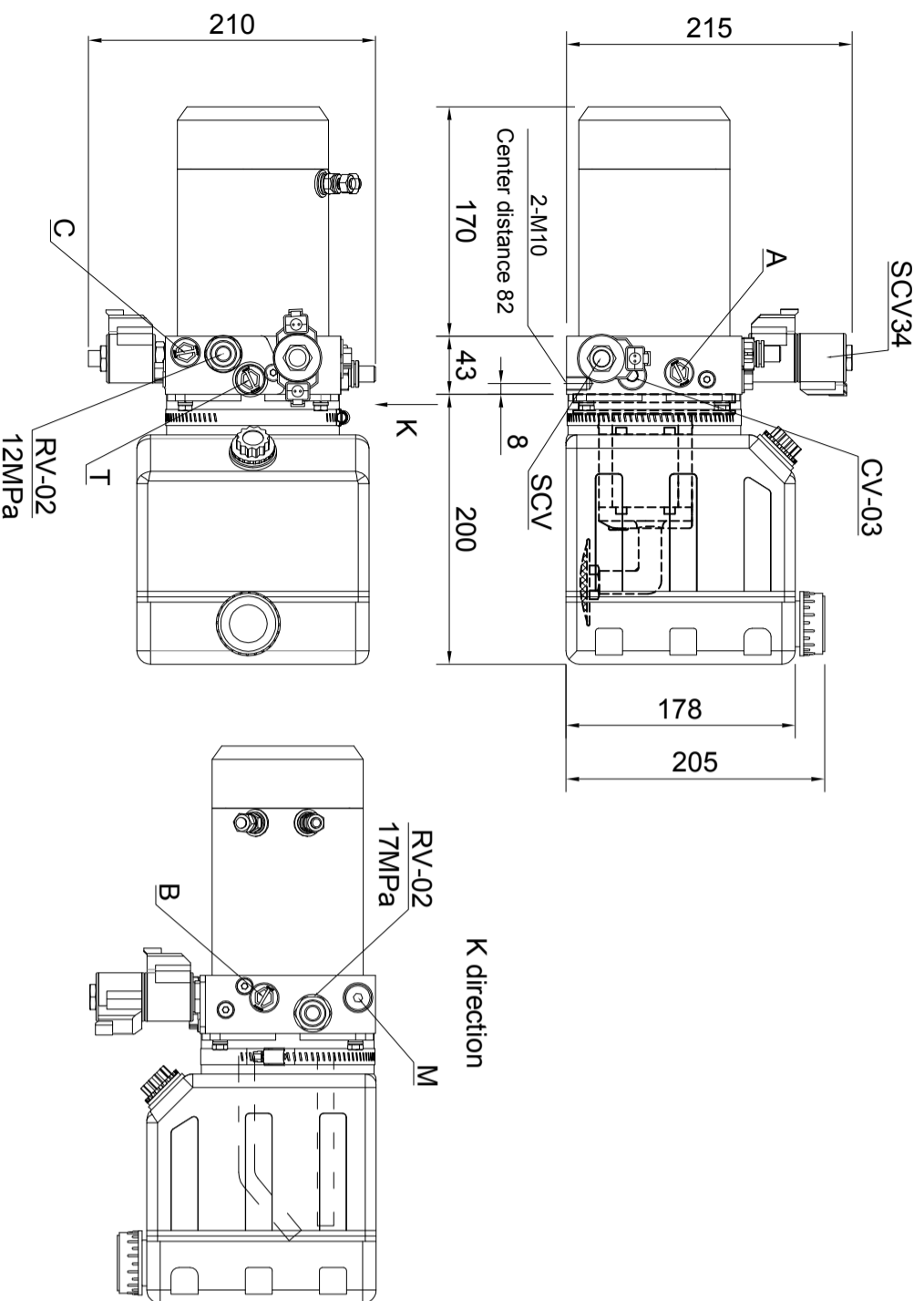

Hydraulic Schematic Diagram

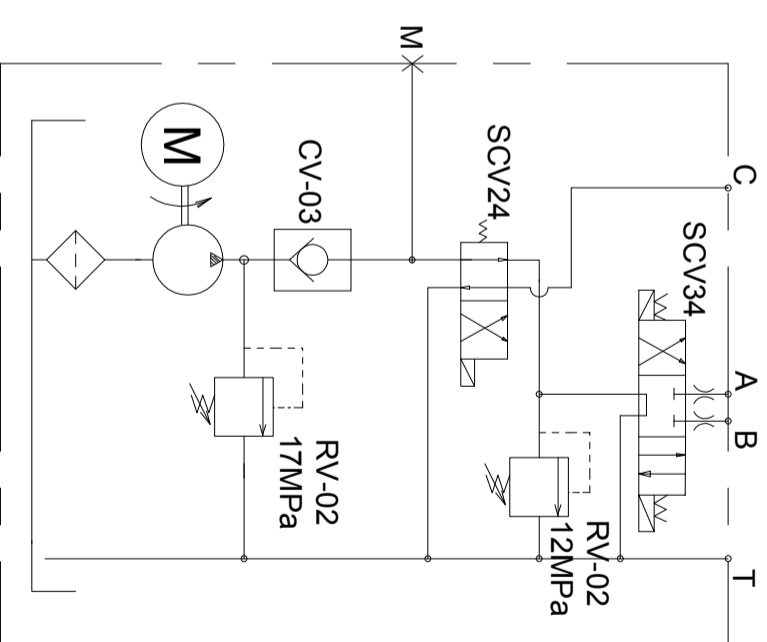

Characteristic curve

